

Features

- Metal construction.
- One-piece faucet, self-contained ceramic disc valve allows both volume and temperature control.
- Temperature memory allows faucet to be turned on and off at any temperature setting.
- High-temperature limit setting for added safety.
- Lever handle.
- 6" (152 mm) escutcheon plate.
- 5" (127 mm) spout reach.
- Metal pop-up drain with tailpiece.
- Flexible supplies.
- 1.2 gal/min (4.5 l/min) maximum flow rate [max at 60 psi (4.14 bar)].



ADA

CSA B651

OBC

Codes/Standards

ASME A112.18.1/CSA B125.1

NSF/ANSI 61

NSF/ANSI 372

All applicable US Federal and State material regulations

DOE - Energy Policy Act 1992

EPA WaterSense®

California Energy Commission (CEC)

ADA

ICC/ANSI A117.1

CSA B651







OBC

KOHLER® Faucet Lifetime Limited Warranty

See website for detailed warranty information.

Available Colors/Finishes

Color tiles intended for reference only.

Color	Code	Description
	CP	Polished Chrome
	PB	Vibrant® Polished Brass
	G	Brushed Chrome
	BN	Vibrant® Brushed Nickel
	BV	Vibrant® Brushed Bronze
	2BZ	Oil-Rubbed Bronze

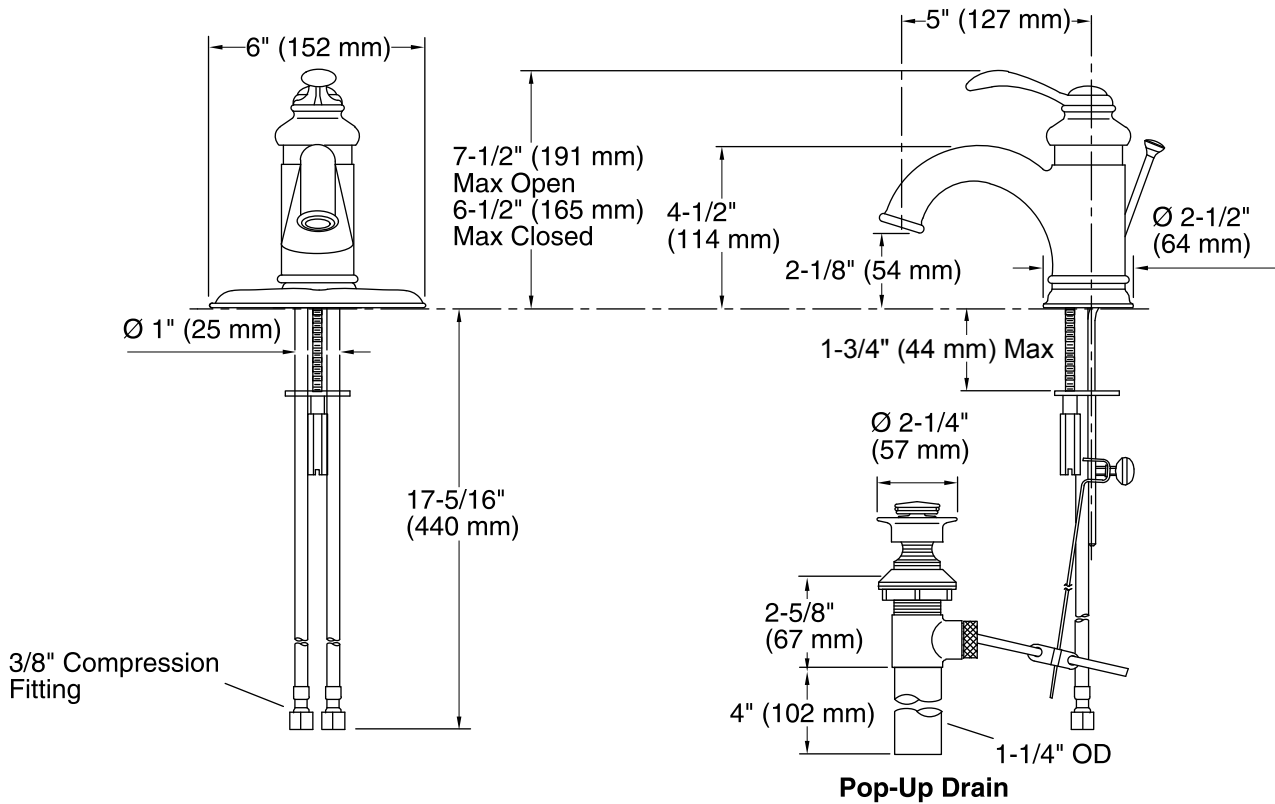

Technical Information

All product dimensions are nominal.

Faucet:

Flow rate: 1.2 gal/min (4.5 l/min)
Pressure: 60 psi (4.1 bar)

Drain included: Yes

Drain tailpiece included: Yes

Spout:

Spout reach: 5" (127 mm)

Notes

Install this product according to the installation guide.

ADA, OBC, CSA B651 compliant when installed to the specific requirements of these regulations.